

RoHS  
COMPLIANT

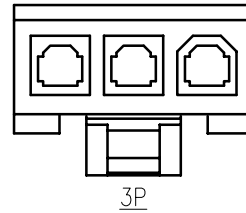
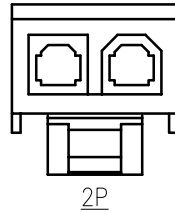
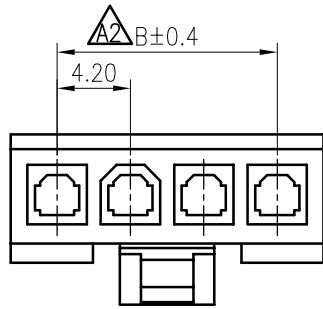

**SPECIFICATIONS**

1. Current rating: 9A(2P AWG#16) AC, DC
2. Voltage rating:600V AC,DC
3. Temperature range: -40°C ~ +105°C
4. Insulation resistance: 1000MΩ/ min.
5. Withstanding voltage: 1500V AC/ minute.
6. Contact resistance: 10mΩ/ max.

Material: Nylon 66 UL94 V-2 or V-0  
Suitable KR4200 series female terminal  
Mate with KR4200 series single row female housing or wafer

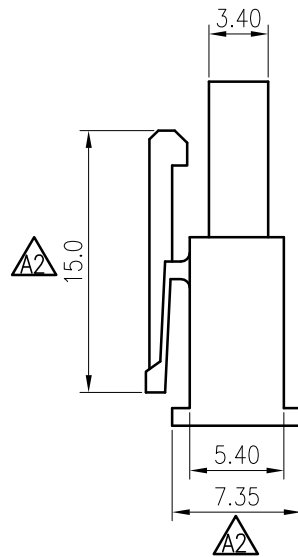
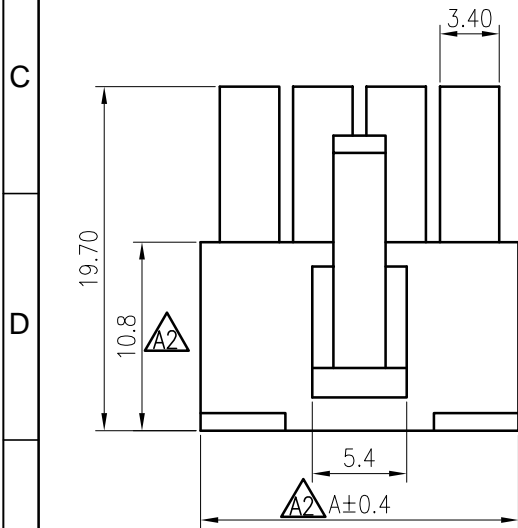

Ordering Code:

H4200M \*\*\* \*\* 01A

No. of Circuits  
102:2,106:6

Insulator Material

01:PA66 White V0

02:PA66 Black V0

04:PA66 Black V2

16:PA66 Transparent V2

Circuits	Dimensions	
	A	B
2	9.55	4.20
3	13.75	8.40
4	17.90	12.60
5	22.25	16.80
6	26.60	21.00

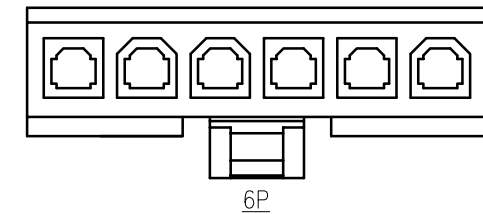
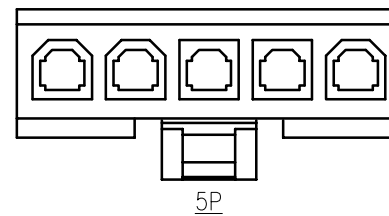

Uniformly arrange the drawings

ZSZ

2022.01.16

Change the part number and frame format

Arvin

2020.04.20

MARK

REVISION DESCRIPTION

SIGNATURE

DATE

TOLERANCE

X. X ±0.30

X. XX ±0.20

X. XXX ±0.10

Angle ±2°

TITLE:

MK4.2 Single Row Male Housing

UNIT: mm

SCALE: N/A

DRAWN: Arvin 2020.04.20

CHECKED:

APPROVED:

SHEET: 1/1

PROJECTION

KONNRA 东莞市康瑞电子有限公司  
DongGuan Konnra Electronics Co., Ltd.

PART NO. : H4200M xxx xx01A

REV. : A4

DRAWING NO. : 4200HM01-A-S