

RoHS
COMPLIANT

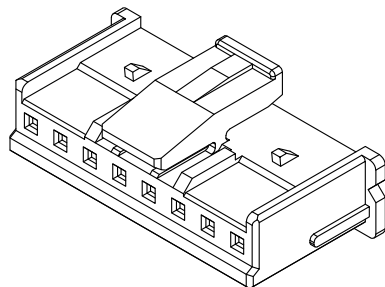
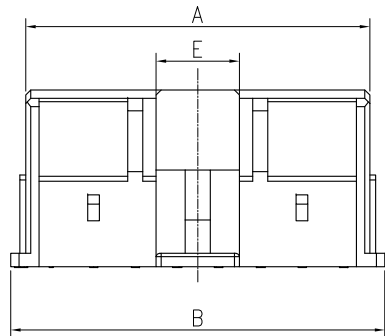

SPECIFICATIONS

1. Current rating: 3.0A AC, DC
2. Voltage rating: 250V AC,DC
3. Temperature range: -40°C ~ +105°C
4. Insulation resistance: 1000MΩ/ min.
5. Withstanding voltage: 1000V AC/ minute.

Material: Plastic(PA66)

Suitable:

KR2516 series terminal(22AWG~24AWG)

Mated with KR2516 series Wafer

Ordering Code: H251601**0102B

104=1*4P

105=1*5P

01:PA66 WHITE

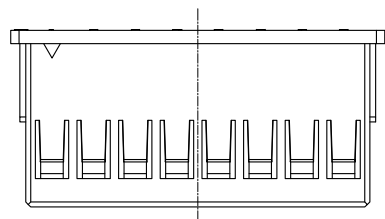
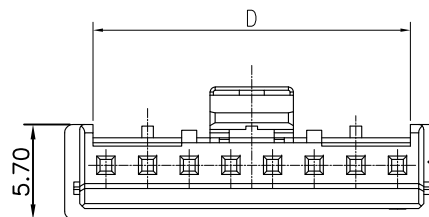
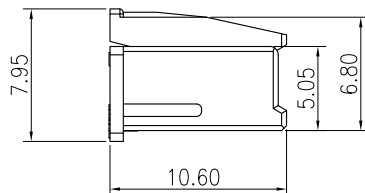
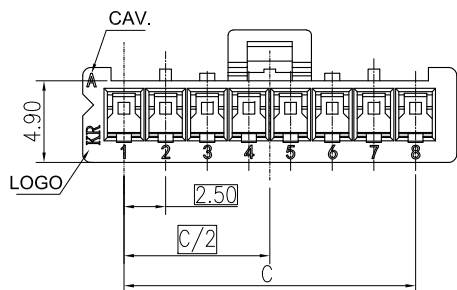

Pin	Dimension				
	A	B	C	D	E
2P	5.65	7.45	2.50	4.05	2.90
3P	8.15	9.95	5.00	5.85	4.40
4P	10.65	12.45	7.50	9.05	5.00
5P	13.15	14.95	10.00	11.55	
6P	15.65	17.45	12.50	14.05	
7P	18.15	19.95	15.00	16.55	
8P	20.65	22.45	17.50	19.05	
9P	23.15	24.95	20.00	21.55	
10P	25.65	27.45	22.50	24.05	
11P	28.15	29.95	25.00	26.55	
12P	30.65	32.45	27.50	29.05	
13P	33.15	34.95	30.00	31.55	
14P	35.65	37.45	32.50	34.05	
15P	38.15	39.95	35.00	36.55	

TOLERANCE
X.X ±0.30
X.XX ±0.20
X.XXX ±0.10
Angle ±2°

TITLE:
XA2.5 Housing

DRAWN: XYH 2023.04.03

CHECKED:

APPROVED:

KONNRA 东莞市康瑞电子有限公司
DongGuan Konnra Electronics Co.,Ltd.

PART NO.: H251601**0102B



NEW DWG

XYH

2023.04.03

MARK

REVISION DESCRIPTION

SIGNATURE

DATE

UNIT:mm

SCALE:1/1

SHEET:1/3

PROJECTION

REV.:A1

DRAWING NO.:2516H101-A-S

RoHS
COMPLIANT

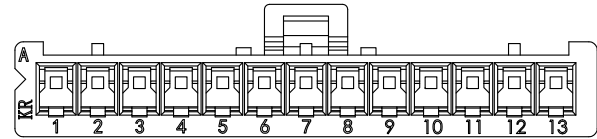
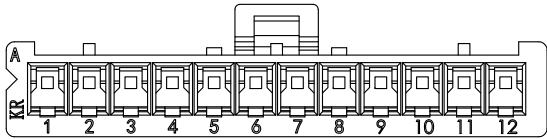
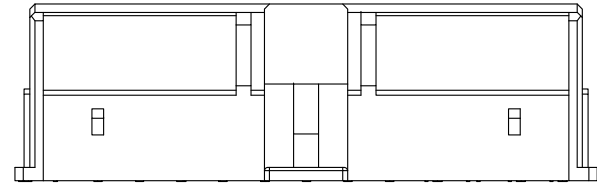
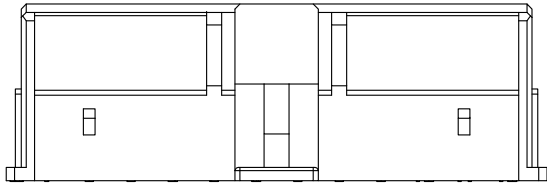

12视图

13P视图

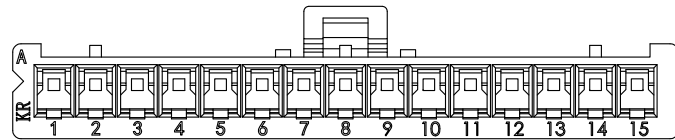
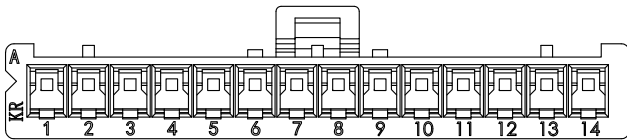
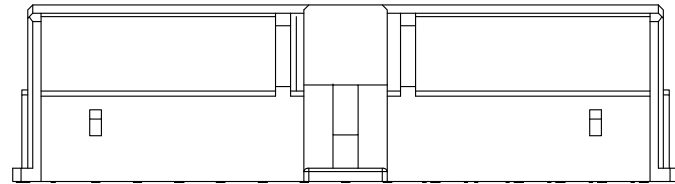
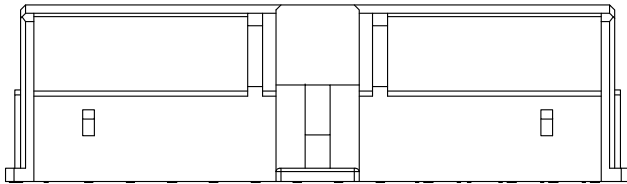

14P视图

15P视图

F					TOLERANCE	TITLE:	DRAWN: Shen 2022.10.14	KONNRA 东莞市康瑞电子有限公司		
					X.X ±0.30	XA2.5 Housing	CHECKED:	DongGuan Konnra Electronics Co.,Ltd.		
		NEW DWG	Shen	2022.10.14	X.XX ±0.20		APPROVED:	PART NO.: H251601****01B		
	MARK	REVISION DESCRIPTION	SIGNATURE	DATE	X.XXX ±0.10	UNIT:mm	SCALE:1/1	SHEET:3/3	PROJECTION	REV.:A1
	1	2	3	4		5	6	7	8	9

Angle ±2°

RoHS
COMPLIANT

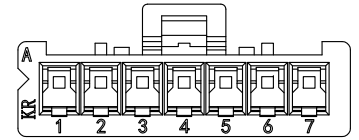
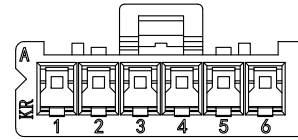
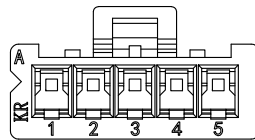
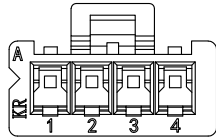
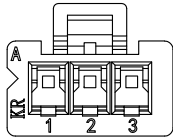
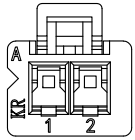
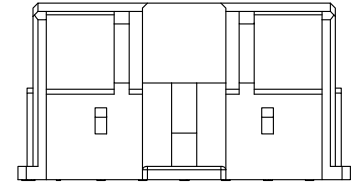
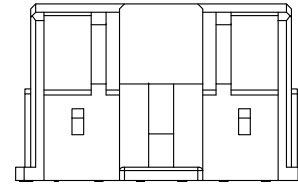
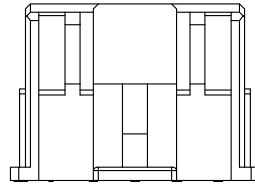
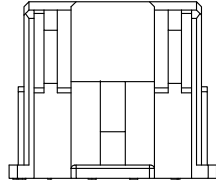
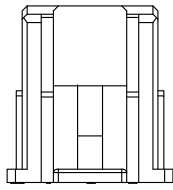
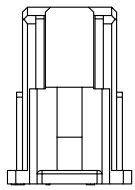

2P视图

3P视图

4P视图

5P视图

6P视图

7P视图

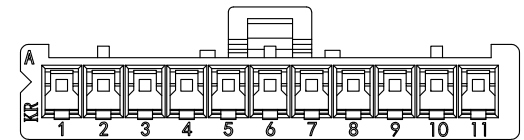
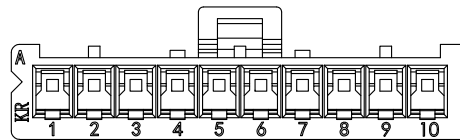
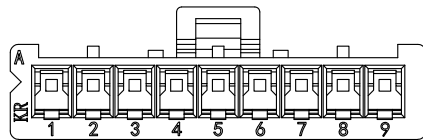
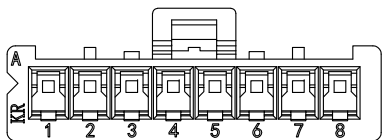
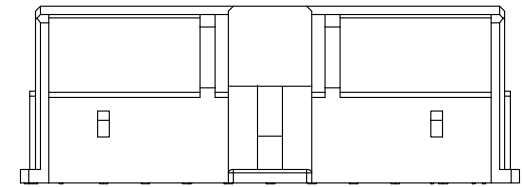
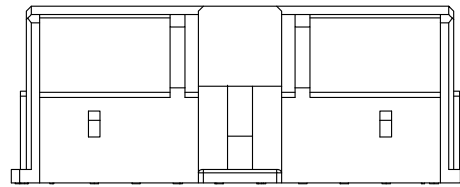
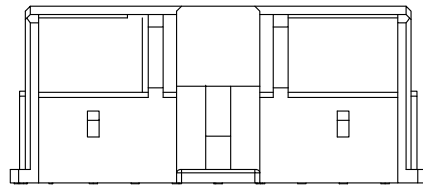
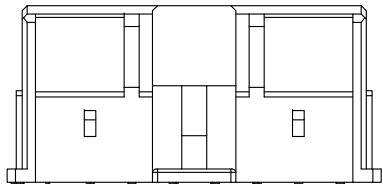

8P视图

9P视图

10P视图

11P视图



MARK

1

2

3

4

5

6

7

8

9

TOLERANCE
X.X ±0.30
X.XX ±0.20
X.XXX ±0.10
Angle ±2°

TITLE:
XA2.5 Housing

UNIT:mm SCALE:1/1

DRAWN: Shen 2022.10.14

CHECKED:

APPROVED:

SHEET:2/3 PROJECTION

KONNRA 东莞市康瑞电子有限公司
DongGuan Konnra Electronics Co.,Ltd.

PART NO.:H251601****01B

REV.:A1 DRAWING NO.:2516H101-A-S

RoHS
COMPLIANT

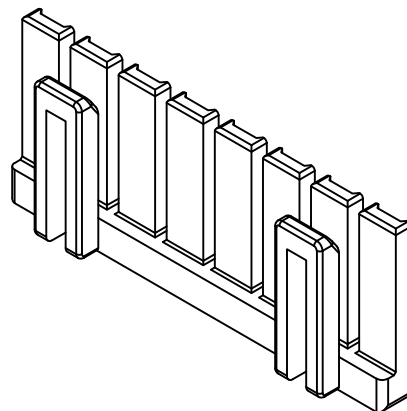
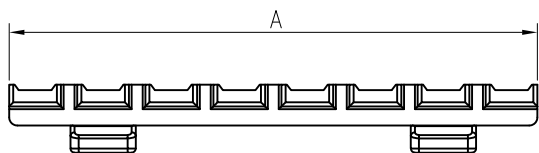

SPECIFICATIONS

1. Current rating: 3.0A AC, DC
2. Voltage rating: 250V AC,DC
3. Temperature range: -25°C ~ +85°C
4. Insulation resistance: 500MΩ/ min.
5. Withstanding voltage: 500V AC/ minute.

Material: Plastic(PA66)

Suitable:

Mated with KR2516 series housing

Ordering Code: H251601****11B

104=1*4P

105=1*5P

01:PA66 WHITE

24:PA66 CREAM

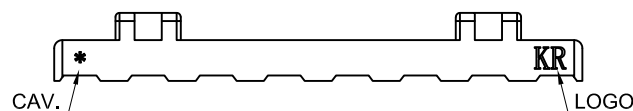
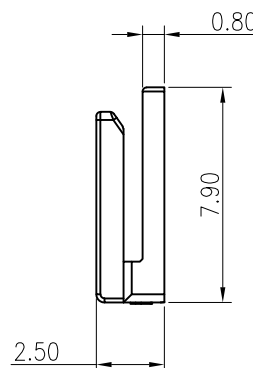
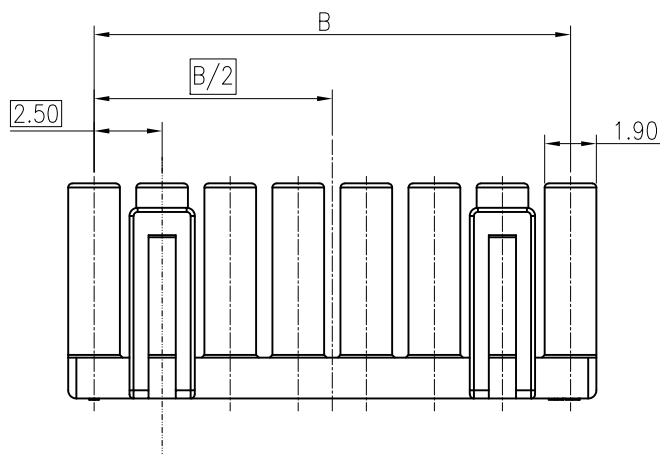

Pin	Dimension	
	A	B
2P	4.40	2.50
3P	6.90	5.00
4P	9.40	7.50
5P	11.90	10.00
6P	14.40	12.50
7P	16.90	15.00
8P	19.40	17.50
9P	21.90	20.00
10P	24.40	22.50
11P	26.90	25.00
12P	29.40	27.50
13P	31.90	30.00
14P	34.40	32.50
15P	36.90	35.00

TOLERANCE
X.X ±0.30
X.XX ±0.20
X.XXX ±0.10
Angle ±2°

TITLE:
XA2.5 TPA

DRAWN: XYH 2023.04.03

CHECKED:

APPROVED:

KONNRA 东莞市康瑞电子有限公司
DongGuan Konnra Electronics Co.,Ltd.

PART NO.: H251601****11B



NEW DWG

XYH

2023.04.03

MARK

REVISION DESCRIPTION

SIGNATURE

DATE

UNIT:mm

SCALE:1/1

SHEET:1/1

PROJECTION

REV.:A1

DRAWING NO.:2016H111-B-Q

1

2

3

4

5

6

7

8

9

RoHS
COMPLIANT

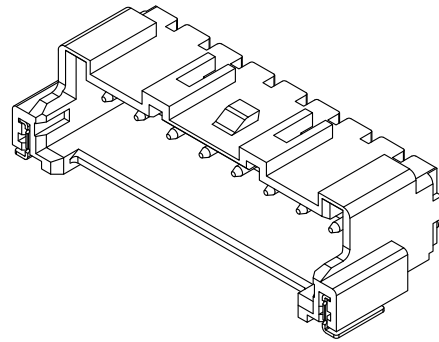
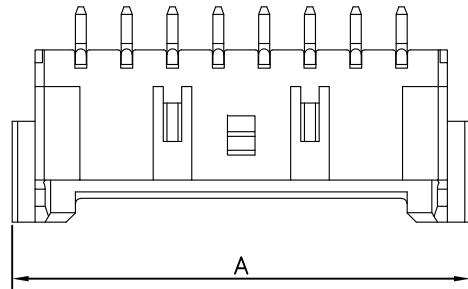

SPECIFICATIONS

1. Current rating: 3.0A AC, DC
2. Voltage rating: 250V AC, DC
3. Temperature range: -25°C ~ +85°C
4. Insulation resistance: 500MΩ/ min.
5. Withstanding voltage: 500V AC/ minute.
6. Contact resistance: 20mΩ/ max.

Material:

Insulator: Plastic(PA9T)

Contact: BRASS

Plating: 1um MIN Matte Tin plated over Nickel

Circuits: SEE TABLE

Mates With KR2516 Series Housing

Ordering Code: C2516RS1*** T0100PA

102=1*2P

103=1*3P

.....

P:BAG

11:PA9T WHITE

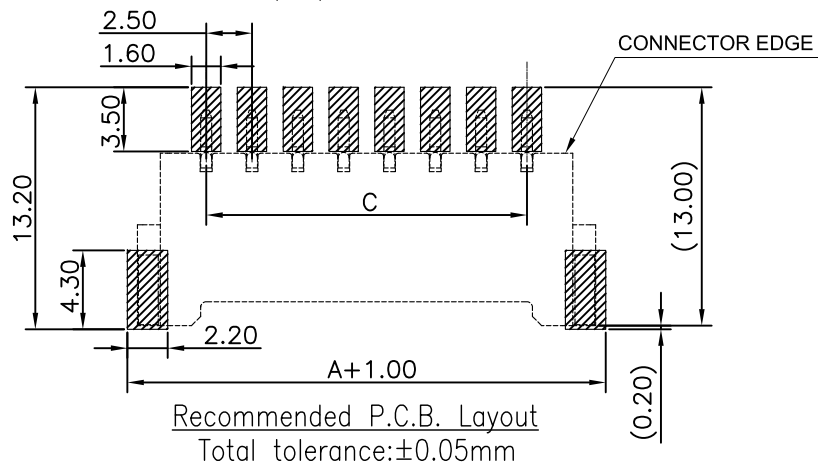
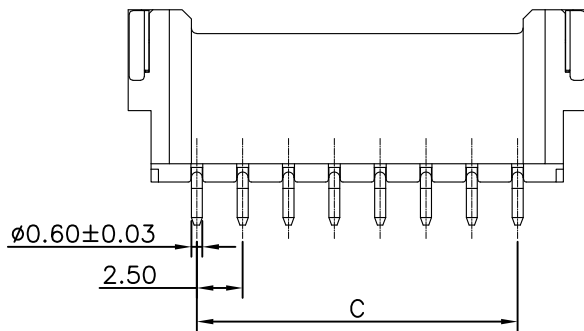
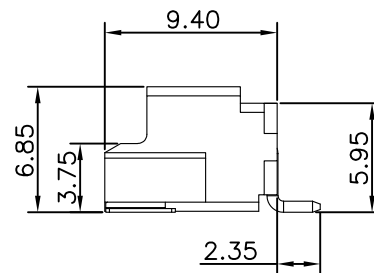
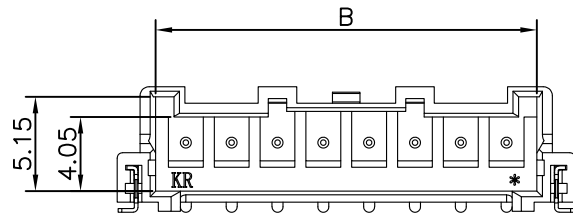

TABLE:

Pin	Dimension		
	A	B	C
2P	10.00	5.80	2.50
3P	12.50	8.30	5.00
4P	15.00	10.80	7.50
5P	17.50	13.30	10.00
6P	20.00	15.80	12.50
7P	22.50	18.30	15.00
8P	25.00	20.80	17.50
9P	27.50	23.30	20.00
10P	30.00	25.80	22.50
11P	32.50	28.30	25.00
12P	35.00	30.80	27.50
13P	37.50	33.30	30.00
14P	40.00	35.80	32.50
15P	42.50	38.30	35.00

TOLERANCE
X.X ±0.30
X.XX ±0.20
X.XXX ±0.10
Angle ±2°

TITLE:
XA2.5 SMT 90° WF

DRAWN: *XYH* 2023.03.30

CHECKED:

APPROVED:

UNIT:mm

SCALE:1/1

SHEET:1/2

PROJECTION

KONNRA 东莞市康瑞电子有限公司
DongGuan Konnra Electronics Co.,Ltd.

PART NO.:C2516RS1****T0100PA

REV.:A1 DRAWING NO.:2516WRS101-A-S



NEW DWG

XYH

2023.03.30

MARK

REVISION DESCRIPTION

SIGNATURE

DATE

1

2

3

4

5

6

7

8

9

RoHS
COMPLIANT

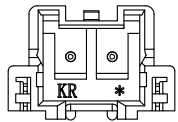

2P视图

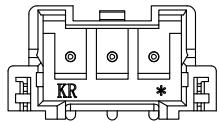

3P视图

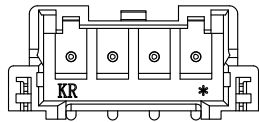

4P视图

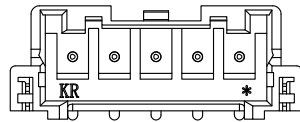

5P视图

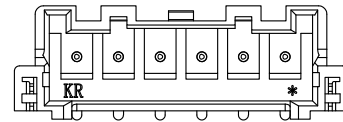

6P视图

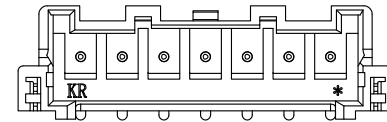

7P视图

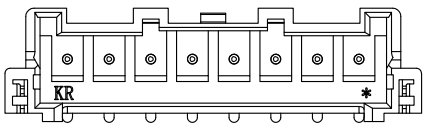

8P视图

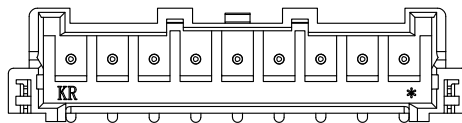

9P视图

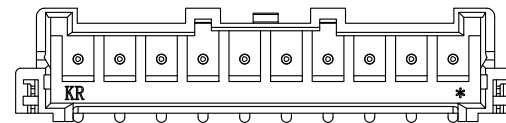

10P视图

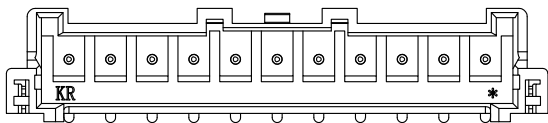

11P视图

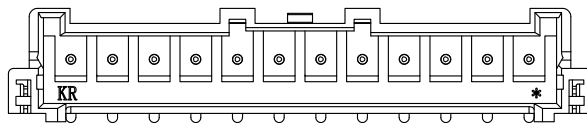

12P视图

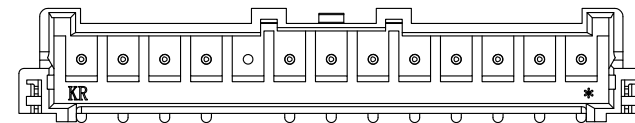

13P视图

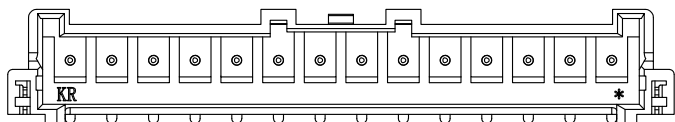

14P视图

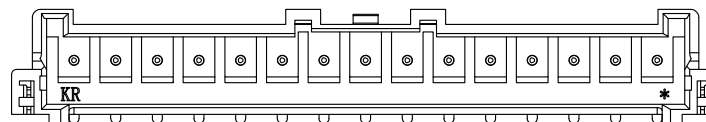

15P视图

TOLERANCE
X.X ±0.30
X.XX ±0.20
X.XXX ±0.10
Angle ±2°

TITLE:
XA2.5 SMT 90° WF

DRAWN: *XYH* 2023.03.30

CHECKED:

APPROVED:

UNIT:mm SCALE:1/1

SHEET:2/2 PROJECTION

KONNRA 东莞市康瑞电子有限公司
DongGuan Konnra Electronics Co.,Ltd.

PART NO.:C2516RS1****T0100PA

REV.:A1 DRAWING NO.:2516WRS101-A-S



NEW DWG

XYH

2023.03.30

MARK

REVISION DESCRIPTION

SIGNATURE

DATE

1

2

3

4

5

6

7

8

9

RoHS
COMPLIANT

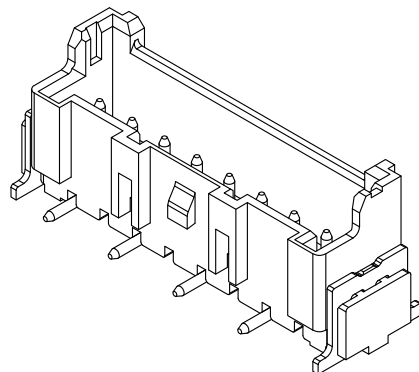
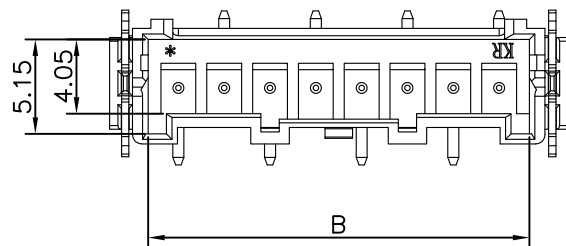

SPECIFICATIONS

1. Current rating: 3.0A AC, DC
2. Voltage rating: 250V AC, DC
3. Temperature range: -25°C ~ +85°C
4. Insulation resistance: 500MΩ/ min.
5. Withstanding voltage: 500V AC/ minute.
6. Contact resistance: 20mΩ/ max.

Material:

Insulator: Plastic(PA9T)

Contact: BRASS

Plating: 1um MIN Matte Tin plated over Nickel

Circuits: SEE TABLE

Mates With KR2516 Series Housing

Ordering Code: C2516VS1** **T0100PA

102=1*2P

103=1*3P

.....

P:BAG

11:PA9T WHITE

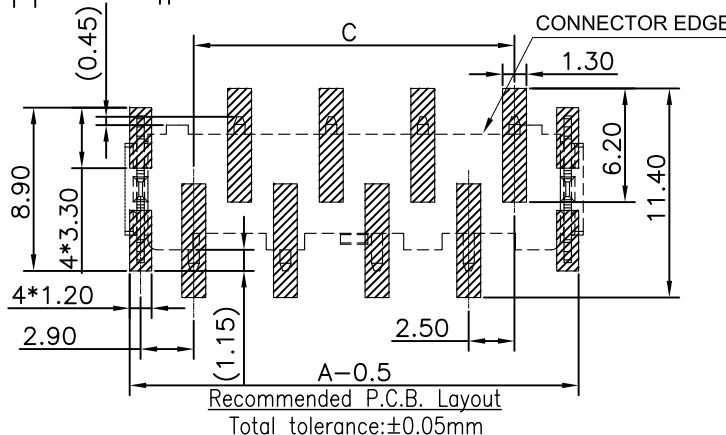
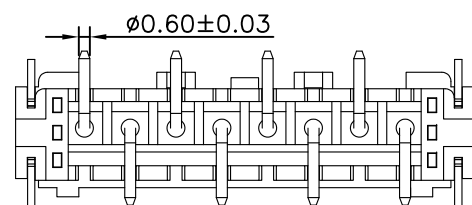
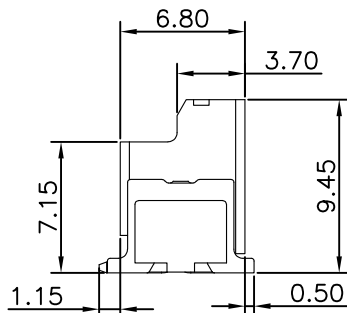
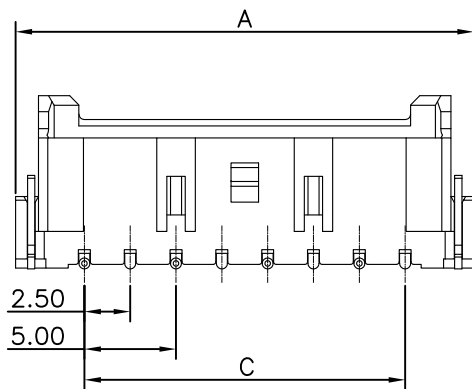

TABLE:

Pin	Dimension		
	A	B	C
2P	10.00	5.80	2.50
3P	12.50	8.30	5.00
4P	15.00	10.80	7.50
5P	17.50	13.30	10.00
6P	20.00	15.80	12.50
7P	22.50	18.30	15.00
8P	25.00	20.80	17.50
9P	27.50	23.30	20.00
10P	30.00	25.80	22.50
11P	32.50	28.30	25.00
12P	35.00	30.80	27.50
13P	37.50	33.30	30.00
14P	40.00	35.80	32.50
15P	42.50	38.30	35.00

TOLERANCE
X.X ±0.30
X.XX ±0.20
X.XXX ±0.10
Angle ±2°

TITLE:
XA2.5 SMT 180° WF
UNIT:mm SCALE:1/1

DRAWN: *XYH* 2023.03.30
CHECKED:
APPROVED:
SHEET:1/2 PROJECTION

KONNRA 东莞市康瑞电子有限公司
DongGuan Konnra Electronics Co.,Ltd.
PART NO.: C2516VS1****T0100PA
REV.:A1 DRAWING NO.: 2516WVS101-A-S

	NEW DWG	XYH	2023.03.30
MARK	REVISION DESCRIPTION	SIGNATURE	DATE

RoHS
COMPLIANT

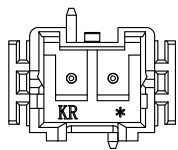

2P视图

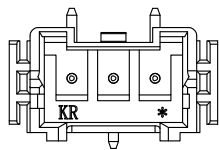

3P视图

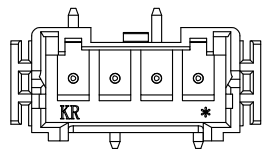

4P视图

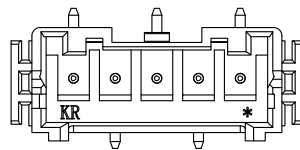

5P视图

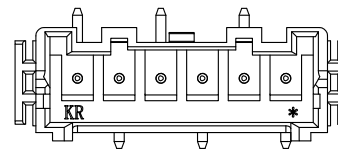

6P视图

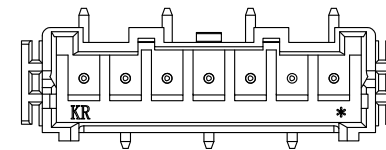

7P视图

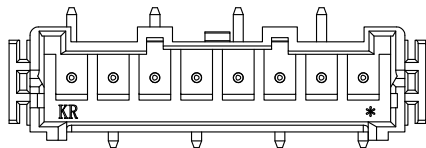

8P视图

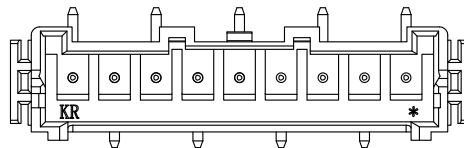

9P视图

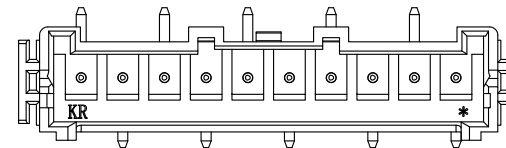

10P视图

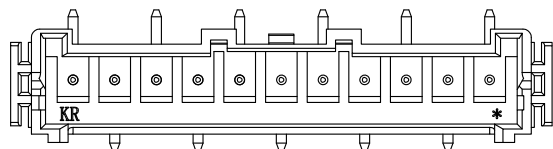

11P视图

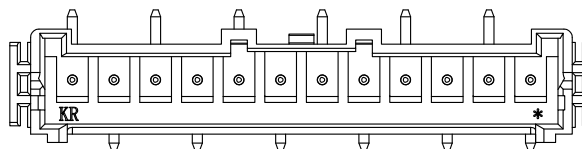

12P视图

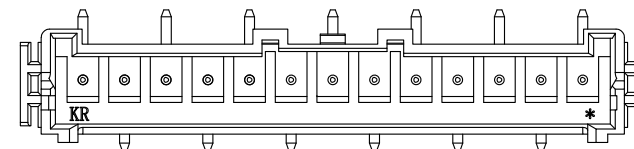

13P视图

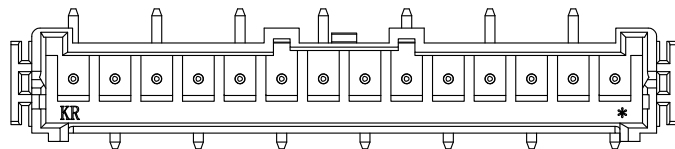

14P视图

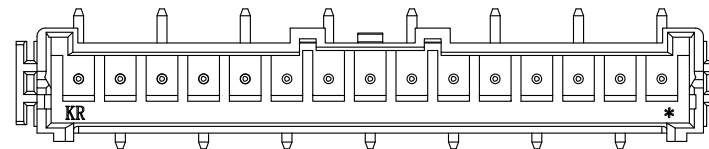

15P视图



MARK

1

2

3

4

5

6

7

8

9

TOLERANCE
X.X ±0.30
X.XX ±0.20
X.XXX ±0.10
Angle ±2°

TITLE:
XA2.5 SMT 180° WF
UNIT:mm SCALE:1/1

DRAWN: XYH 2023.03.30
CHECKED:
APPROVED:
SHEET:2/2 PROJECTION

KONNRA 东莞市康瑞电子有限公司
DongGuan Konnra Electronics Co.,Ltd.
PART NO.:C2516VS1****T0100PA
REV.:A1 DRAWING NO.:2516WVS101-A-S

NEW DWG

XYH

2023.03.30

REVISION DESCRIPTION

SIGNATURE

DATE

UNIT:mm SCALE:1/1

SHEET:2/2 PROJECTION

REV.:A1 DRAWING NO.:2516WVS101-A-S

RoHS
COMPLIANT

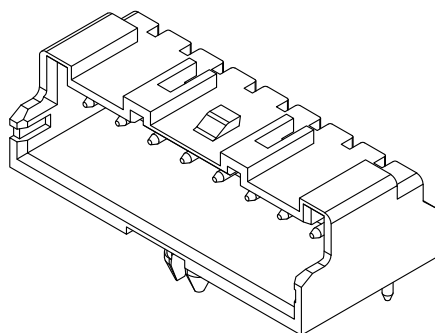

SPECIFICATIONS

1. Current rating: 3.0A AC, DC
2. Voltage rating: 250V AC, DC
3. Temperature range: -25°C ~ +85°C
4. Insulation resistance: 500MΩ/ min.
5. Withstanding voltage: 500V AC/ minute.
6. Contact resistance: 20mΩ/ max.

Material:

Insulator: Plastic(PA9T)

Contact: BRASS

Plating: 1um MIN Matte Tin plated over Nickel

Circuits: SEE TABLE

Mates With KR2516 Series Housing

Ordering Code: C2516RD1** **T01**PA

102=1*2P

103=1*3P

....

P:BAG

01:无柱

02:有柱

01:PA66 WHITE

24:PBT WHITE

TABLE:

Pin	Dimension		
	A	B	C
2P	7.50	5.80	2.50
3P	10.00	8.30	5.00
4P	12.50	10.80	7.50
5P	15.00	13.30	10.00
6P	17.50	15.80	12.50
7P	20.00	18.30	15.00
8P	22.50	20.80	17.50
9P	25.00	23.30	20.00
10P	27.50	25.80	22.50
11P	30.00	28.30	25.00
12P	32.50	30.80	27.50
13P	35.00	33.30	30.00
14P	37.50	35.80	32.50
15P	40.00	38.30	35.00

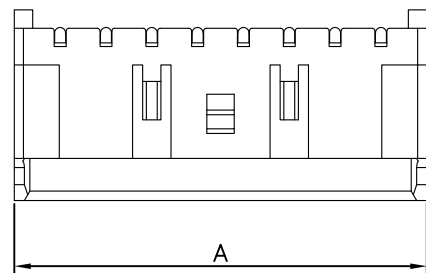

A

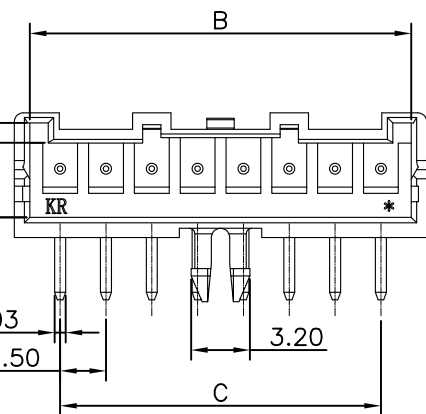

B

C

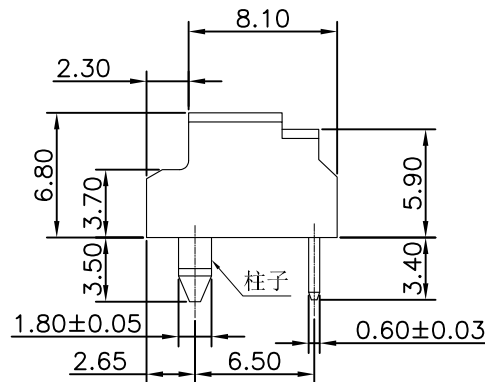

(有柱)

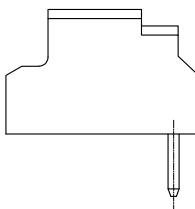

(无柱)

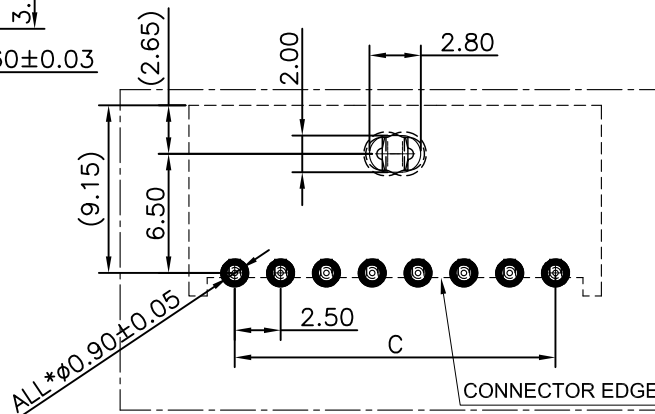

Recommended P.C.B. Layout
Total tolerance:±0.05mm

∅0.60±0.03

2.50

C

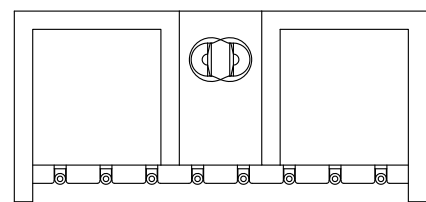

NEW DWG

XYH

2023.03.30

TOLERANCE
X.X ±0.30
X.XX ±0.20
X.XXX ±0.10
Angle ±2°

TITLE:
XA2.5 DIP 90° WF

DRAWN: XYH 2023.03.30

CHECKED:

APPROVED:

KONNRA 东莞市康瑞电子有限公司
DongGuan Konnra Electronics Co.,Ltd.

PART NO.: C2516RD1****T01**PA

MARK

REVISION DESCRIPTION

SIGNATURE

DATE

UNIT:mm

SCALE:1/1

SHEET:1/2

PROJECTION

REV.:A1

DRAWING NO.:2516WRD101-A-S

1

2

3

4

5

6

7

8

9

RoHS
COMPLIANT

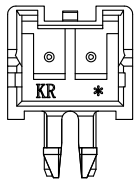

2P视图

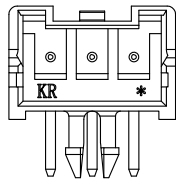

3P视图

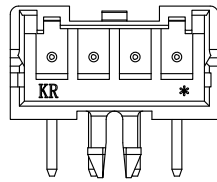

4P视图

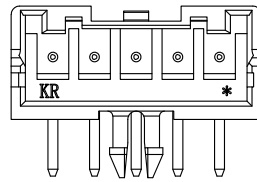

5P视图

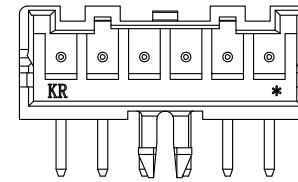

6P视图

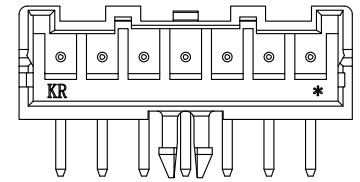

7P视图

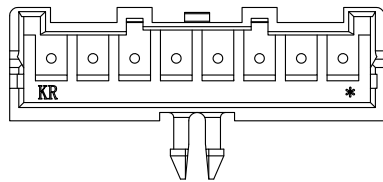

8P视图

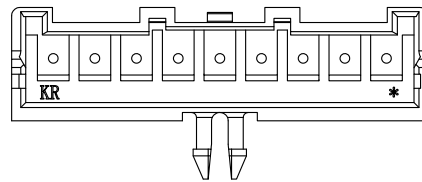

9P视图

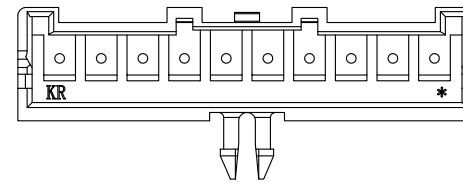

10P视图

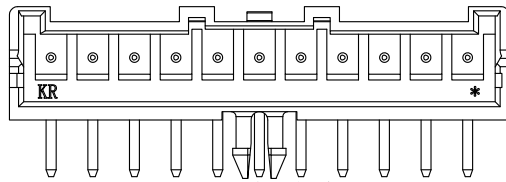

11P视图

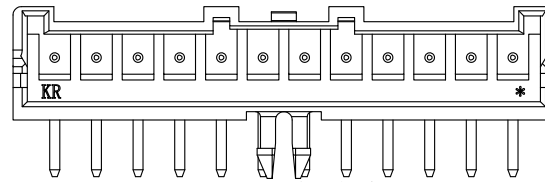

12P视图

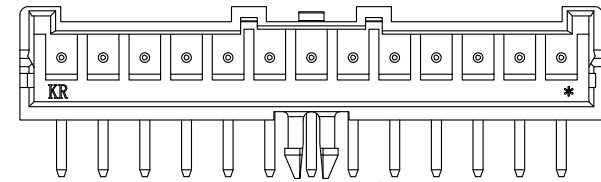

13P视图

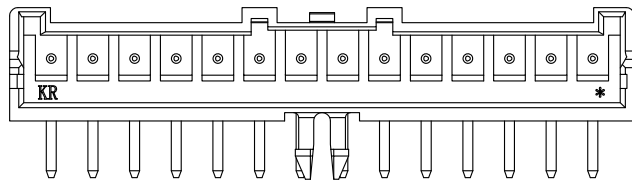

14P视图

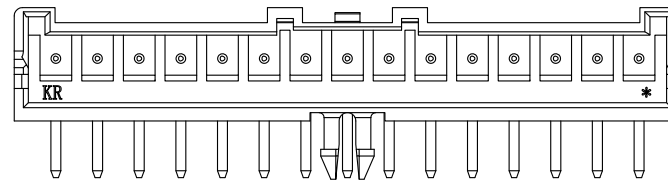

15P视图

A3

A2

A1

MARK

NEW DWG

REVISION DESCRIPTION

XYH

SIGNATURE

2023.03.30

DATE

TOLERANCE

X.X ±0.30

X.XX ±0.20

X.XXX ±0.10

Angle ±2°

TITLE:
XA2.5 DIP 90° WF

UNIT:mm

SCALE:1/1

DRAWN: XYH 2023.03.30

CHECKED:

APPROVED:

SHEET:2/2

PROJECTION

KONNRA 东莞市康瑞电子有限公司
DongGuan Konnra Electronics Co.,Ltd.

PART NO.:C2516RD1****T01**PA

REV.:A1

DRAWING NO.:2516WRD101-A-S

1

2

3

4

5

6

7

8

9

RoHS
COMPLIANT

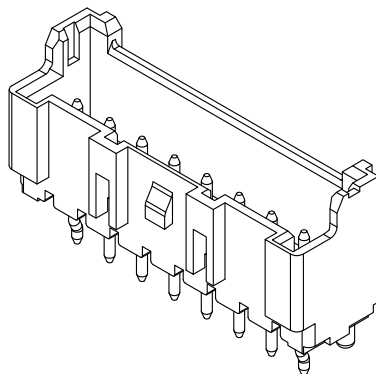
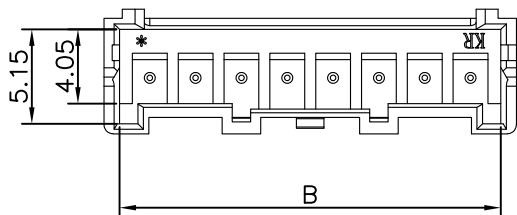

SPECIFICATIONS

1. Current rating: 3.0A AC, DC
2. Voltage rating: 250V AC, DC
3. Temperature range: -25°C ~ +85°C
4. Insulation resistance: 500MΩ/ min.
5. Withstanding voltage: 500V AC/ minute.
6. Contact resistance: 20mΩ/ max.

Material:

Insulator: Plastic(PA9T)

Contact: BRASS

Plating: 1um MIN Matte Tin plated over Nickel

Circuits: SEE TABLE

Mates With KR2516 Series Housing

Ordering Code: C2516VD1** **T01**PA

102=1*2P
103=1*3P
....

P:BAG
01:无柱
02:有柱
01:PA66 WHITE
24:PBT WHITE

TABLE:

Pin	Dimension		
	A	B	C
2P	7.50	5.80	2.50
3P	10.00	8.30	5.00
4P	12.50	10.80	7.50
5P	15.00	13.30	10.00
6P	17.50	15.80	12.50
7P	20.00	18.30	15.00
8P	22.50	20.80	17.50
9P	25.00	23.30	20.00
10P	27.50	25.80	22.50
11P	30.00	28.30	25.00
12P	32.50	30.80	27.50
13P	35.00	33.30	30.00
14P	37.50	35.80	32.50
15P	40.00	38.30	35.00

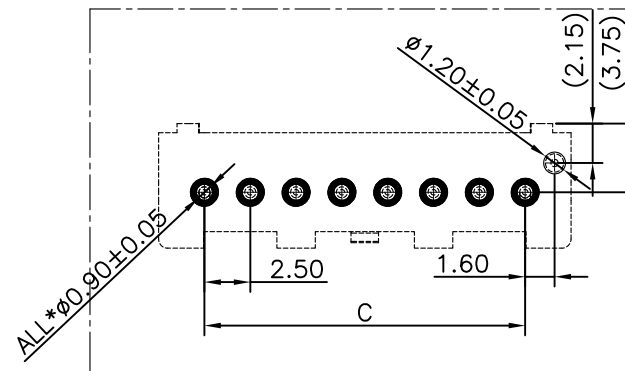
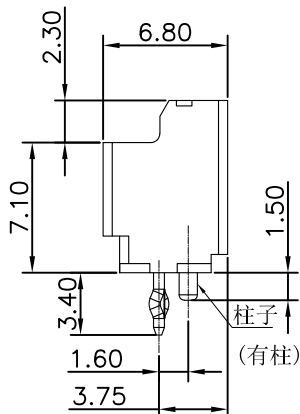
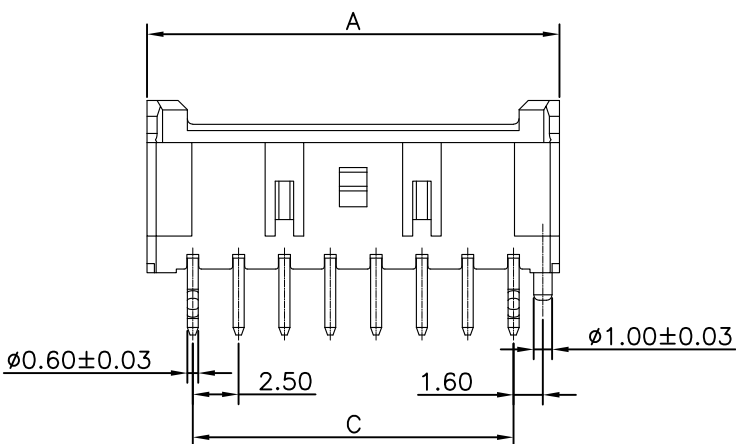

Recommended P.C.B. Layout
Total tolerance:±0.05mm

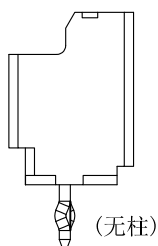
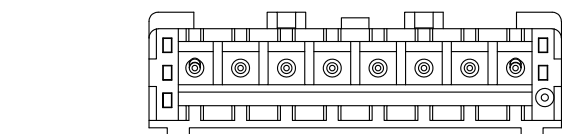

				TOLERANCE	TITLE:		DRAWN: <i>XYH</i> 2023.03.30		KONNRA 东莞市康瑞电子有限公司	
				X.X ±0.30	XA2.5 DIP 180° WF		CHECKED:		DongGuan Konnra Electronics Co.,Ltd.	
				X.XX ±0.20			APPROVED:		PART NO.: C2516VD1****T01**PA	
				X.XXX ±0.10			SHEET: 1/2		REV.: A1	
				Angle ±2°			PROJECTION		DRAWING NO.: 2516WVD101-A-S	
MARK	REVISION DESCRIPTION	SIGNATURE	DATE	UNIT:mm	SCALE:1/1					

RoHS
COMPLIANT

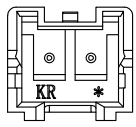

2P视图

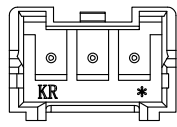

3P视图

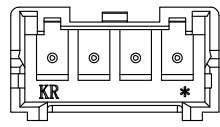

4P视图

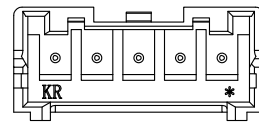

5P视图

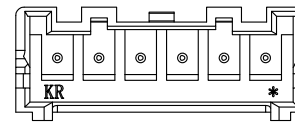

6P视图

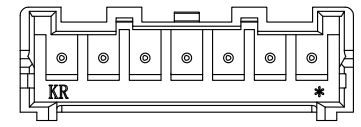

7P视图

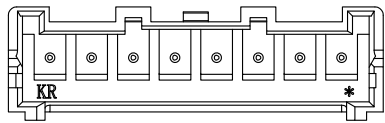

8P视图

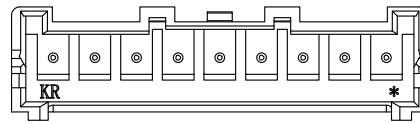

9P视图

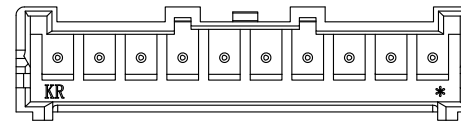

10P视图

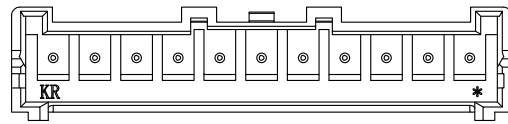

11P视图

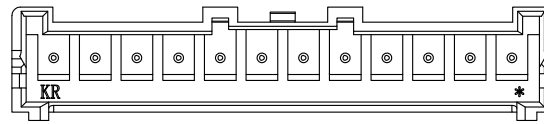

12P视图

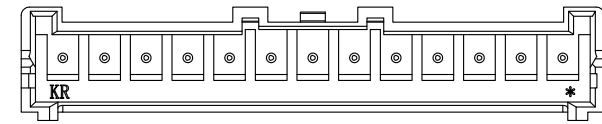

13P视图

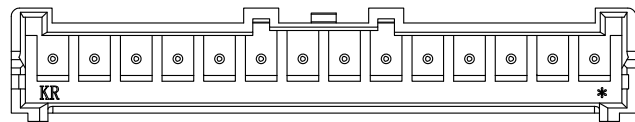

14P视图

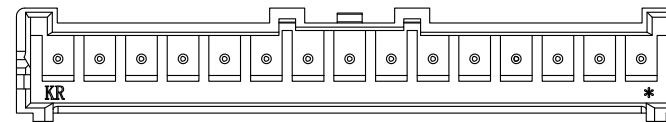

15P视图



MARK

NEW DWG

REVISION DESCRIPTION

XYH

SIGNATURE

2023.03.30

DATE

TOLERANCE
X.X ±0.30
X.XX ±0.20
X.XXX ±0.10
Angle ±2°

TITLE:
XA2.5 DIP 180° WF

UNIT:mm

SCALE:1/1

DRAWN: XYH 2023.03.30

CHECKED:

APPROVED:

SHEET:2/2

PROJECTION

KONNRA 东莞市康瑞电子有限公司
DongGuan Konnra Electronics Co.,Ltd.

PART NO.:C2516VD1****T01**PA

REV.:A1

DRAWING NO.:2516WVD101-A-S

1

2

3

4

5

6

7

8

9